

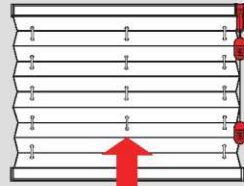

Bediening / Operation / Utilisation - plissé top-down

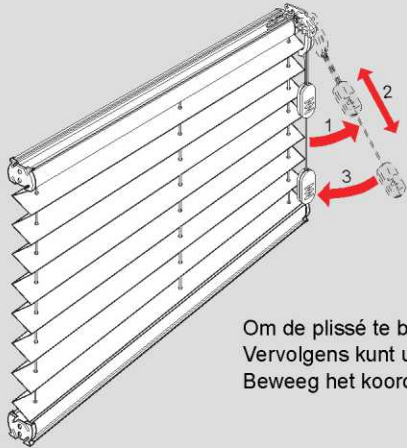

onderzijde

Om de plissé te bedienen, brengt u het koord in een hoek naar voren (1). Vervolgens kunt u het koord laten vieren of naar beneden trekken (2). Beweeg het koord richting plissé om tekeren op de gewenste hoogte (3).

Veiligheidsvoorschrift / Safety / Sécurité

Neem dit veiligheidsvoorschrift a.u.b. in acht: Voor uw veiligheid!
For your own safety: Please follow the safety instructions!
Veuillez respecter la consigne de sécurité: Pour votre sécurité!

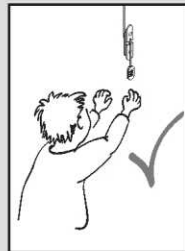
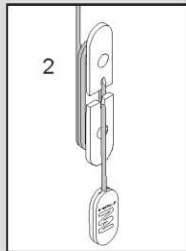
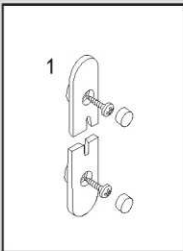
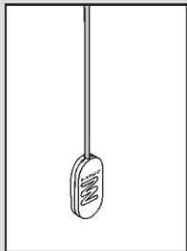

Bovenzijde montage Top x mounting

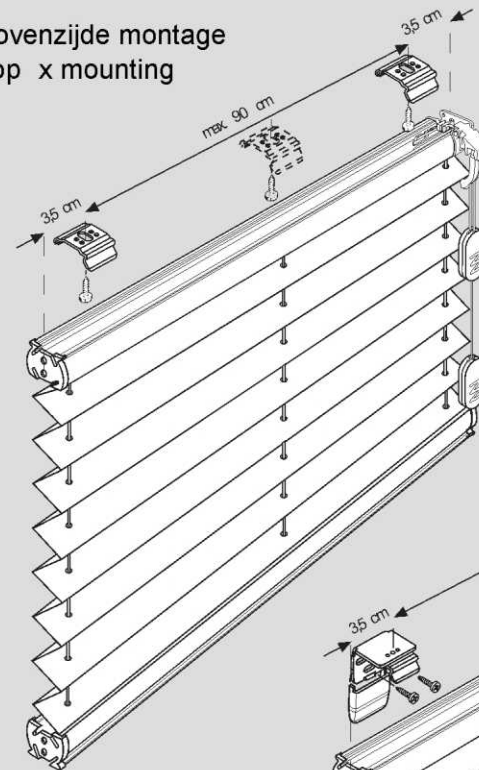

Monteer beugels aan de uiteinden met het schroefgat op 3,5 cm vanaf de zijde van de plissé. Tussen twee beugels mag max. 90cm ruimte zitten.

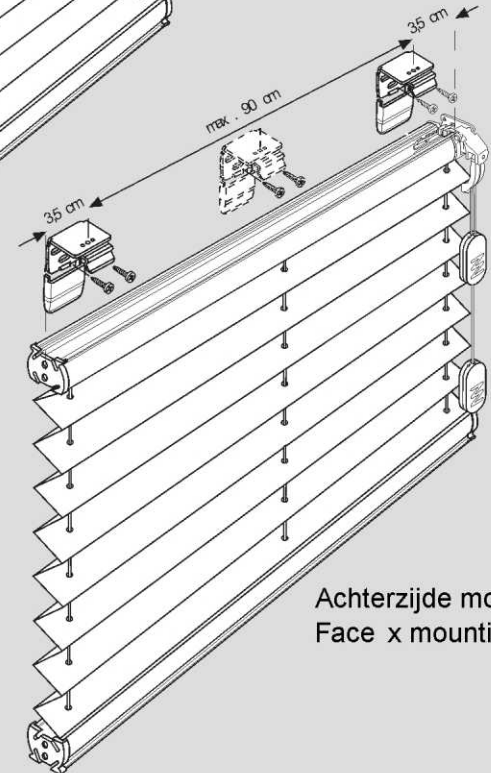

Achterzijde montage
Face x mounting

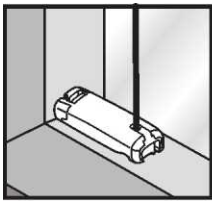

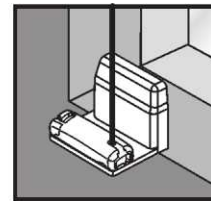

Bevestiging in de sponning (in-beugel)
 Top xing
 Dans la feuillure



Bevestiging met hoeksteun (op-beugel)
 Face xing
 Avec equerre de xation



Montage / Fitting / Montage

Plissé  Honingraatstof 

1 17 mm
 5 mm
 5 mm
 5 mm
 15 mm
 17 mm

1 19 mm
 5 mm
 5 mm
 5 mm
 15 mm
 19 mm

2 **3** **4** **5**



6 **7** **8** **9**

10

Demontage / Disassembly / Demontage

1 **2** **3**

Montage / Fitting / Montage

Plissé  & Honingraatstof 

1 **2**

Uitlijning beugel met onderrail plissé

3 **4** **5** **6** **7**

8 **9** **10** **11** **12**

13

Demontage / Disassembly / Demontage

1 **2** **3**

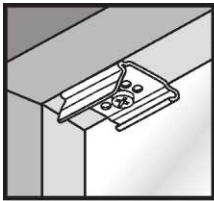

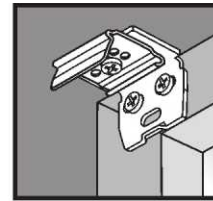

Bovenzijde montage
(in vensternis / in de dag)
Top x mounting
Dans la feuillure



Achterzijde montage
(op vensternis / op de dag)
Face x mounting
Avec equerre de xation



Montage
Fitting
Montage

Positie schroefgat bij: Plissé  Honingraatstof 

1

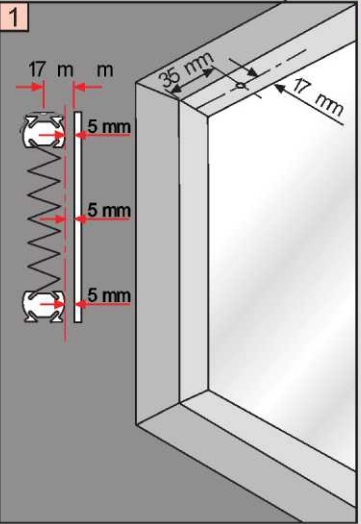
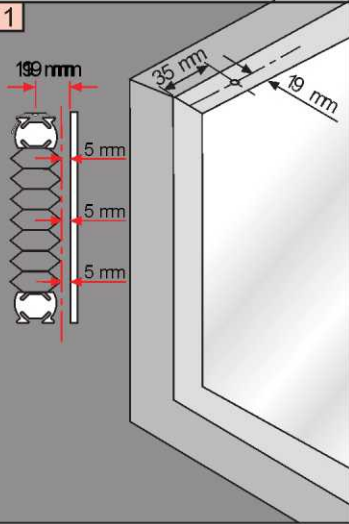

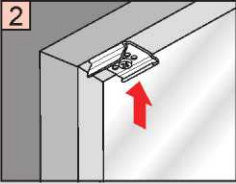

2



3

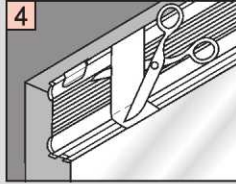

4

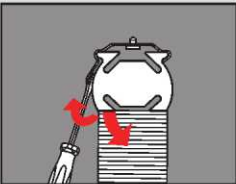

Demontage / Disassembly / Demontage



Montage
Fitting
Montage

Plissé  & Honingraatstof 

1

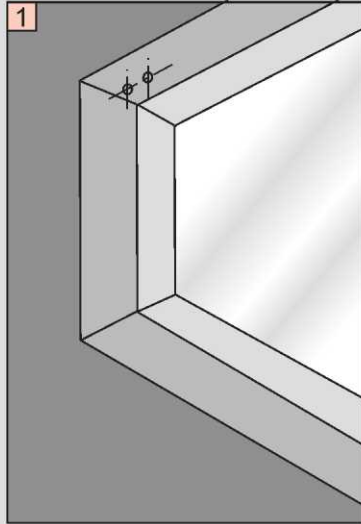

2

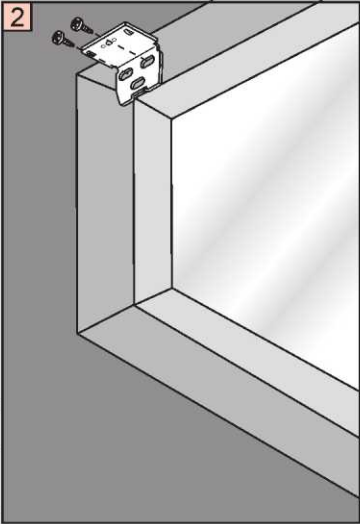

3

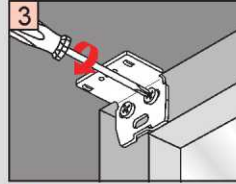

4

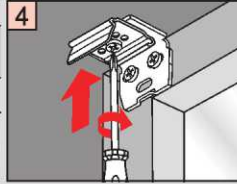

5

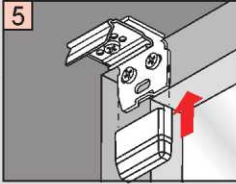

6

7

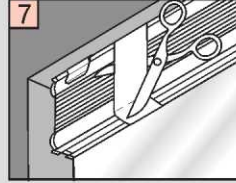

Demontage / Disassembly / Demontage

