

# Montage Plissé top-down

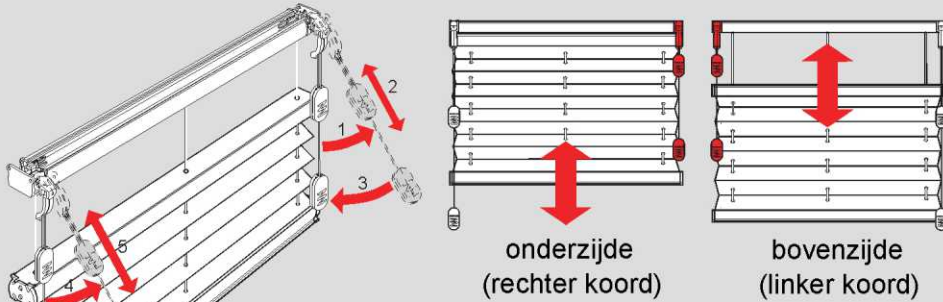

## Bediening / Operation / Utilisation - plissé top-down



Om de plissé te bedienen, brengt u het koord in een hoek naar voren (1 of 4). Vervolgens kunt u het koord laten vieren of naar beneden trekken (2 of 5). Beweeg het koord richting plissé om te keren op de gewenste hoogte (3 of 6).

## Veiligheidsvoorschrift / Safety / Sécurité

Neem dit veiligheidsvoorschrift a.u.b. in acht: Voor uw veiligheid!  
For your own safety: Please follow the safety instructions!  
Veuillez respecter la consigne de sécurité: Pour votre sécurité!

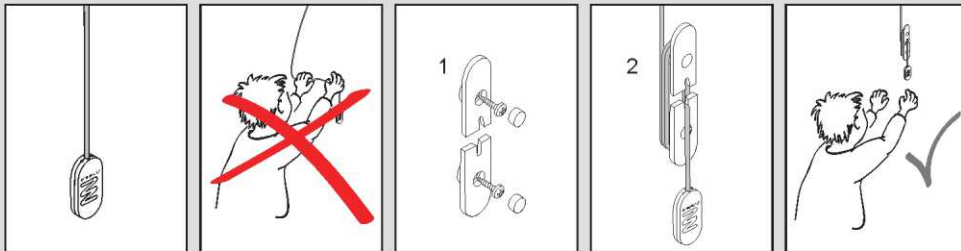

## Bovenzijde montage Top x mounting

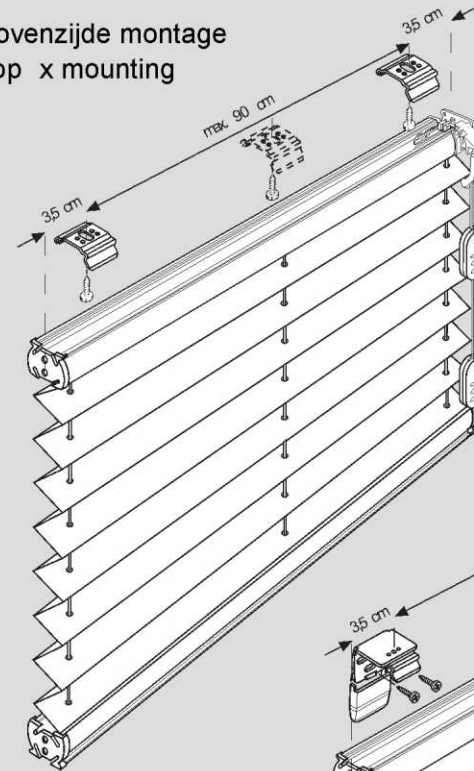

Weergegeven is een standaard plissé. Montage is gelijk bij top-down plissés.

Monteer beugels aan de uiteinden met het schroefgat op 3,5 cm vanaf de zijde van de plissé. Tussen twee beugels mag max. 90cm ruimte zitten.

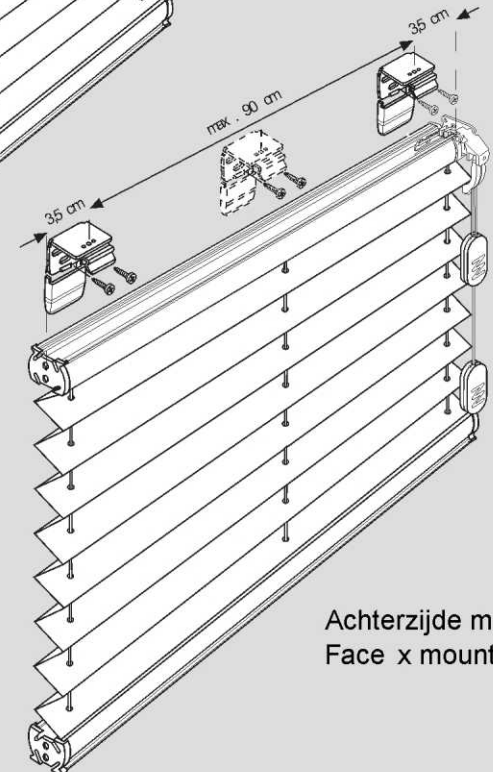

## Achterzijde montage Face x mounting

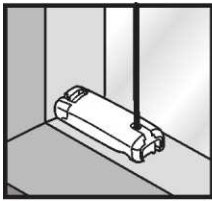

Bevestiging in de sponning (in-beugel)  
 Top xing  
 Dans la feuillure

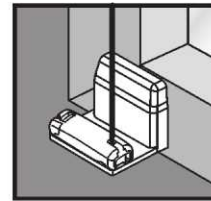

Bevestiging met hoeksteun (op-beugel)  
 Face xing  
 Avec equerre de xation



**Montage / Fitting / Montage**

<b>Plissé</b> 		<b>Honingraatstof</b> 	
<b>Demontage / Disassembly / Demontage</b>			

**Montage / Fitting / Montage**

**Uitlijning beugel met onderrail plissé**

<b>Plissé &amp; Honingraatstof</b> 			
<b>Demontage / Disassembly / Demontage</b>			



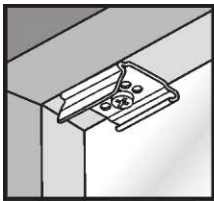

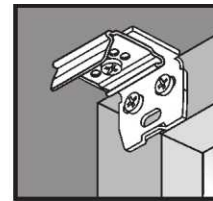

Bovenzijde montage  
(in vensternis / in de dag)  
Top x mounting  
Dans la feuillure



Achterzijde montage  
(op vensternis / op de dag)  
Face x mounting  
Avec equerre de xation



Montage  
Fitting  
Montage

Positie schroefgat bij: **Plissé**  **Honingraatstof** 

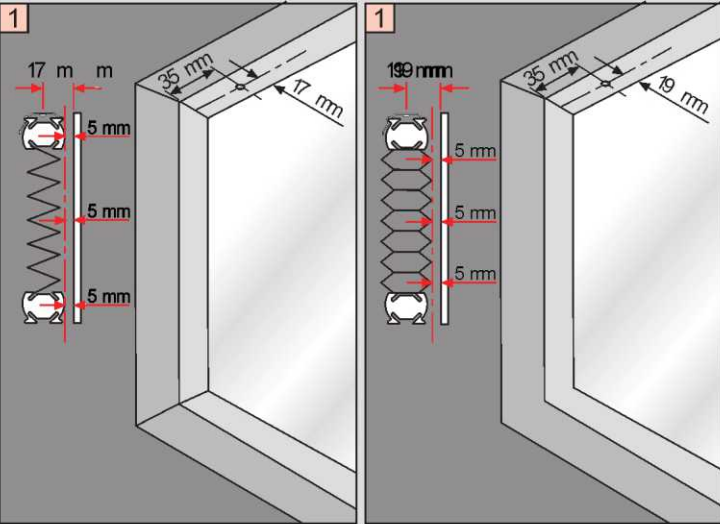
**1** 

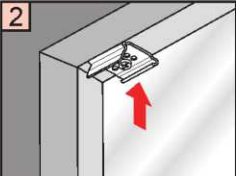
**2** 

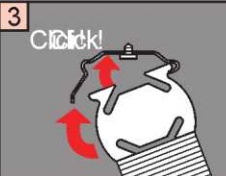

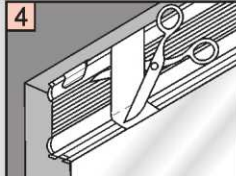
**3** 

**4** 

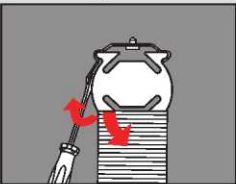
**Demontage / Disassembly / Demontage**



Montage  
Fitting  
Montage

Plissé  & Honingraatstof 

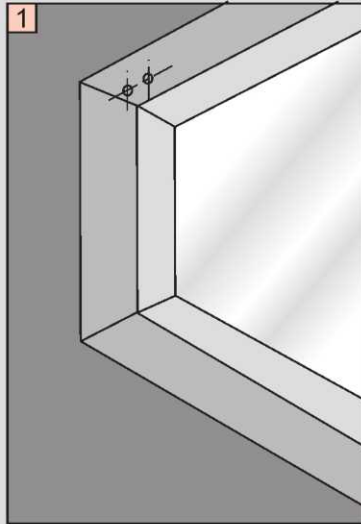
**1** 

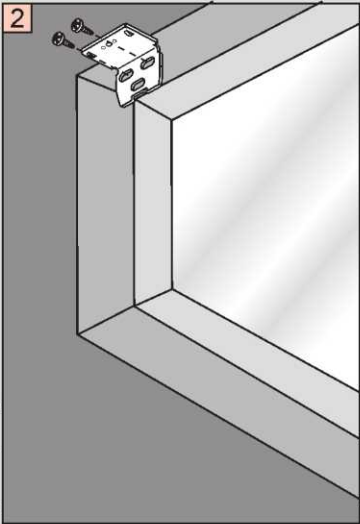
**2** 

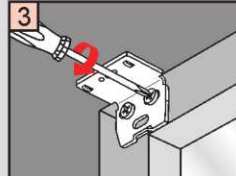
**3** 

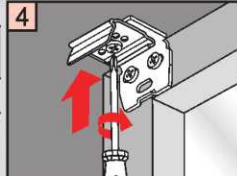
**4** 

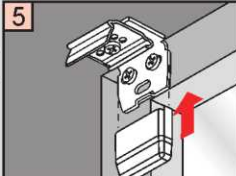
**5** 

**6** 

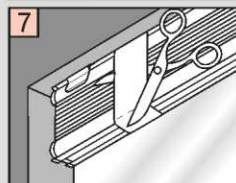
**7** 

**Demontage / Disassembly / Demontage**

